

37100C/37200C/37300C

Vector Network Analyzers

Technical Data Sheet

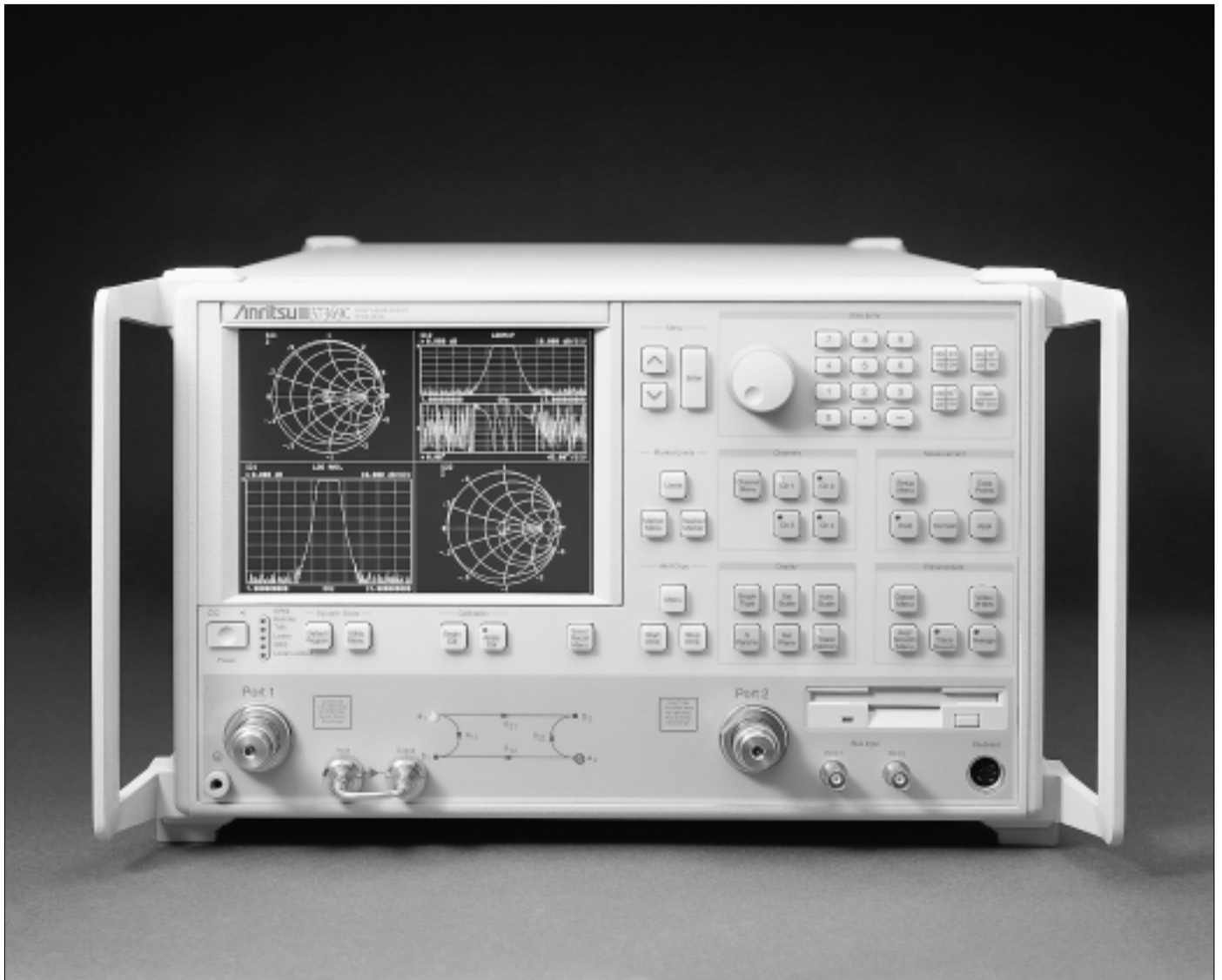

Vector Network Analysis up to 65 GHz

SYSTEM DESCRIPTION

The Lightning 37200C/37300C Vector Network Analyzers (VNAs) are high performance tools designed to make fast and accurate S-parameter measurements of active and passive devices across the 22.5 MHz to 65 GHz range. These network analyzers integrate a synthesized source, S-parameter test set and tuned receiver into a single compact package that is ideal for bench-top testing.

The Lightning 37100C VNAs are configured as Direct-Access Receivers for antenna, frequency conversion, and multiple output device measurements. These network analyzers consist of a synthesized source and tuned receiver in a single compact unit, with direct access provided to all four receiver samplers via the front panel. The 37100C offers the ultimate flexibility to meet most receiver measurement needs, while maintaining the ability to measure all four S-parameters with the addition of a reflectometer setup at the front end of the receiver.

Specifications for the 37100C/37200C/37300C models are detailed on the following pages.

Model Numbers	Frequency Range
37217C, 37317C	22.5 MHz to 8.6 GHz
37225C, 37325C	40 MHz to 13.5 GHz
37147C	22.5 MHz to 20 GHz
37247C, 37347C	40 MHz to 20 GHz
37169C	22.5 MHz to 40 GHz
37269C, 37369C	40 MHz to 40 GHz
37277C, 37377C	40 MHz to 50 GHz
37297C, 37397C	40 MHz to 65 GHz

High throughput measurements are achieved in each model through the use of fast, 12-term error corrected sweeps, fast GPIB data transfers and an intuitive user interface. All measurement results are displayed on a large LCD color display or on an external VGA monitor.

For maximum productivity, the VNAs include as standard features:

- ✓ Fast Sweeping Synthesized Source
- ✓ Auto Reversing Test Set (37200C/37300C models only)
- ✓ Solid-State Transfer Switch (37200C/37300C models only)
- ✓ Four Independent Display Channels
- ✓ Multiple Source Control of Two External Sources
- ✓ Four Channel Receiver
- ✓ Internal Hard and Floppy Disk Drives
- ✓ LRL/LRM Calibration
- ✓ Adapter Removal Calibrations
- ✓ Fast Measurement Throughput via GPIB
- ✓ Built-In AutoCal® Control

Each of the network analyzers is designed for easy upgradeability. Any version of the 37000C VNA can be upgraded to accommodate new capabilities or additional frequency ranges by ordering the appropriate upgrade kit. 37100C to 37200C or 37200C to 37300C upgrades are also supported.

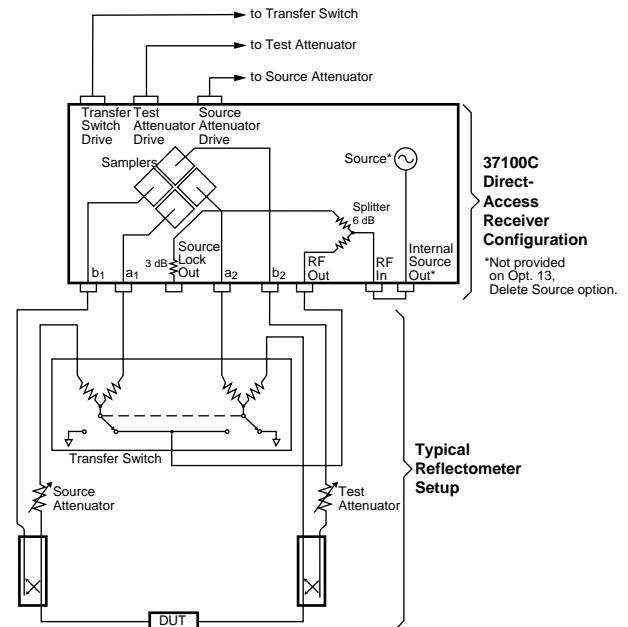

A Reflectometer test set is available as a special option for the 37100C. It contains the transfer switch, both attenuators and couplers. It also offers two bias tees and a front panel amplifier loop for active device testing. As compared to a 37300C VNA, the output power and hence the dynamic range are degraded by 10 dB typically.

SYSTEM PERFORMANCE

Dynamic Range:

The tables on the next page provide two definitions of dynamic range:

"Receiver Dynamic Range" is defined as the difference between the maximum signal level at Port 2 (or at any sampler input: a_1 , a_2 , b_1 , or b_2 for a 37100C) for 0.1 dB compression and the noise floor.

"System Dynamic Range" is defined as the difference between the power incident on Port 2 in a through line connection and the noise floor.

In preparing the tables, 10 Hz IF bandwidth and 512 averages were used in calibration and measurement.

High Level Noise (typical): <0.04 dB and <0.5 degrees peak-to-peak variation in a 1 kHz IF bandwidth up to 20 GHz. <0.08 dB and <1.0 degrees peak-to-peak variation up to 40 GHz. <0.25 dB and <2.5 degrees peak-to-peak variation up to 65 GHz.

Dynamic Range (37100C)

Model	Frequency (GHz)	Maximum Signal Into a _x , b _x (dBm)	Noise Floor (dBm)	Receiver Dynamic Range (dB)	Source Power (dBm, Typical)
37147C	0.0225	-18	-122	104	10
	2	-12	-106	94	8
	20	-12	-103	91	5
37169C	0.0225	-18	-122	104	10
	2	-12	-106	94	8
	20	-12	-103	91	3
	40	-15	-100	85	-3

Dynamic Range (37200C/37300C)

Model	Frequency (GHz)	Max. Signal Into Port 2 (dBm)	Noise Floor (dBm)	Receiver Dynamic Range (dB)	Port 1 Power (dBm, Typical)	System Dynamic Range (dB)*
37217C	0.0225	+3	-95	98	0	95
	2	+3	-98	101	0	98
	8.6	+3	-98	101	0	98
37225C	0.04	+20	-70	90	0	70
	2	+3	-98	101	0	98
	13.5	+3	-98	101	0	98
37247C	0.04	+20	-70	90	0	70
	2	+3	-98	101	0	98
	20	+3	-96	99	0	96
37269C	0.04	+20	-70	90	0	70
	2	+3	-98	101	0	98
	20	+3	-95	98	-5	90
	40	+3	-93	96	-15	78
37277C	0.04	+20	-77	97	0	77
	2	+3	-105	108	+5	110
	20	+3	-97	100	-2	95
	40	+3	-95	98	-7	88
	50	+3	-87	90	-2	85
37297C	0.04	+20	-77	97	0	77
	2	+3	-105	108	+5	110
	20	+3	-97	100	-2	95
	40	+3	-95	98	-7	88
	65	+3	-87	90	-2	85
37317C	0.0225	+30	-95	125	0	95
	2	+30	-98	128	0	98
	8.6	+30	-98	128	0	98
37325C	0.04	+30	-65	95	+5	70
	2	+30	-93	123	+5	98
	13.5	+30	-93	123	+5	98
37347C	0.04	+30	-65	95	+5	70
	2	+30	-93	123	+5	98
	20	+30	-91	121	+5	96
37369C	0.04	+30	-65	95	0	70
	2	+30	-93	123	+5	98
	20	+30	-90	120	0	90
	40	+30	-83	113	-7	76
37377C	0.04	+30	-77	107	0	77
	2	+30	-105	135	+5	110
	20	+30	-97	127	-2	95
	40	+30	-95	125	-7	88
	50	+30	-87	117	-2	85
37397C	0.04	+30	-77	107	0	77
	2	+30	-105	135	+5	110
	20	+30	-97	127	-2	95
	40	+30	-95	125	-7	88
	50	+30	-87	117	-2	85
	65	+30	-77	107	-2	75

*System Dynamic Range is based on the typical Port 1 power and specified noise floor at the indicated frequency range.

Test Port Characteristics

The specifications in the table below apply when the proper Model 34U Universal Test Port Adapters are connected, with or without phase equal insertables, to the test set ports and calibrated with the appropriate calibration kit at 23 ± 3° C using the OSL calibration method with a sliding load to achieve 12-term error correction. (90 min. warm-up time is recommended)

Connector	Frequency (GHz)	Directivity (dB)	Source Match (dB)	Load Match (dB)	Reflection Frequency Tracking (dB)	Transmission Frequency Tracking (dB)	Isolation (dB)
GPC-7	0.0225	>52	>44	>52	±0.003	±0.004	>105
	2	>52	>44	>52	±0.003	±0.004	>115
	18	>52	>42	>52	±0.004	±0.012	>112
GPC-7 LRL Calibration	2	>60	>60	>60	±0.001	±0.001	>115
	8	>60	>60	>60	±0.001	±0.001	>112
N-Type*	0.0225	>46	>36	>46	±0.004	±0.004	>105
	2	>44	>36	>44	±0.004	±0.004	>115
	18	>40	>32	>40	±0.005	±0.012	>112
3.5mm	0.0225	>44	>40	>44	±0.005	±0.030	>105
	2	>44	>40	>44	±0.005	±0.030	>115
	20	>44	>38	>44	±0.006	±0.050	>110
	26.5	>44	>34	>44	±0.006	±0.070	>102
K	0.0225	>42	>40	>42	±0.005	±0.030	>105
	2	>42	>40	>42	±0.005	±0.050	>115
	20	>42	>38	>42	±0.006	±0.070	>110
	40	>38	>34	>38	±0.006	±0.080	>100
V	0.04	>40	>36	>40	±0.050	±0.030	>105
	2	>40	>36	>40	±0.050	±0.050	>115
	20	>40	>36	>40	±0.060	±0.070	>110
	40	>36	>32	>36	±0.060	±0.080	>100
	50	>34	>30	>34	±0.080	±0.100	>90
	65	>34	>28	>34	±0.100	±0.120	>80

*Standard OSL calibration, sliding load not required.

Measurement Throughput: Measurement times are based on a single 40 MHz to 20 GHz sweep with 10 kHz IF bandwidth (no averages) after a full 12-term calibration. Sweep times include retrace and band switch times.

Measurement Time (ms) vs. Data Points (typical)

Calibration Type	Data Points				
	3	51	101	401	1601
1 Port (3 Term)	75	270	350	920	3000
2 Port (12 Term)	60	250	340	920	3000

Measurement Time vs. Sweep Mode for 101 Data Points (typical)

Sweep Mode	Time (ms)
Linear	350
List	350
CW	190

Measurement Time vs. IF BW for 101 Data Points (typical)

IF Bandwidth	Time (ms)
10 kHz	180
1 kHz	270
100 Hz	1100
10 Hz	7300

Measurement Time vs. Span for 101 Data Points (typical)

Frequency Span	Time (ms)
40 MHz to 65 GHz	900
40 MHz to 40 GHz	450
20 GHz to 40 GHz	340
10 GHz to 11 GHz	220

MEASUREMENT UNCERTAINTY

The following graphs give measurement uncertainty after 12-Term vector error correction. The errors are worst case contributions of residual directivity, load and source match, frequency response, isolation, network analyzer dynamic accuracy, and connector repeatability. In preparing the following graphs, 10 Hz IF bandwidth and averaging of 512 points were used. Changes in the IF bandwidth or averaging can result in variations at low levels.

Models 37x47C Series (K-Connectors)

Reflection Measurements:

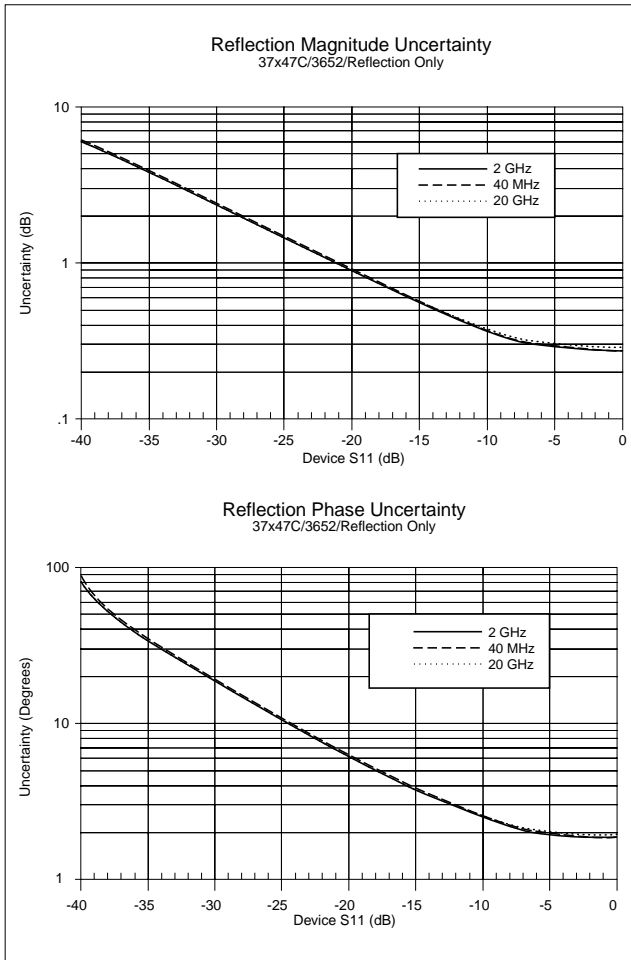

Models 37x47C Series (K-Connectors)

Transmission Measurements:

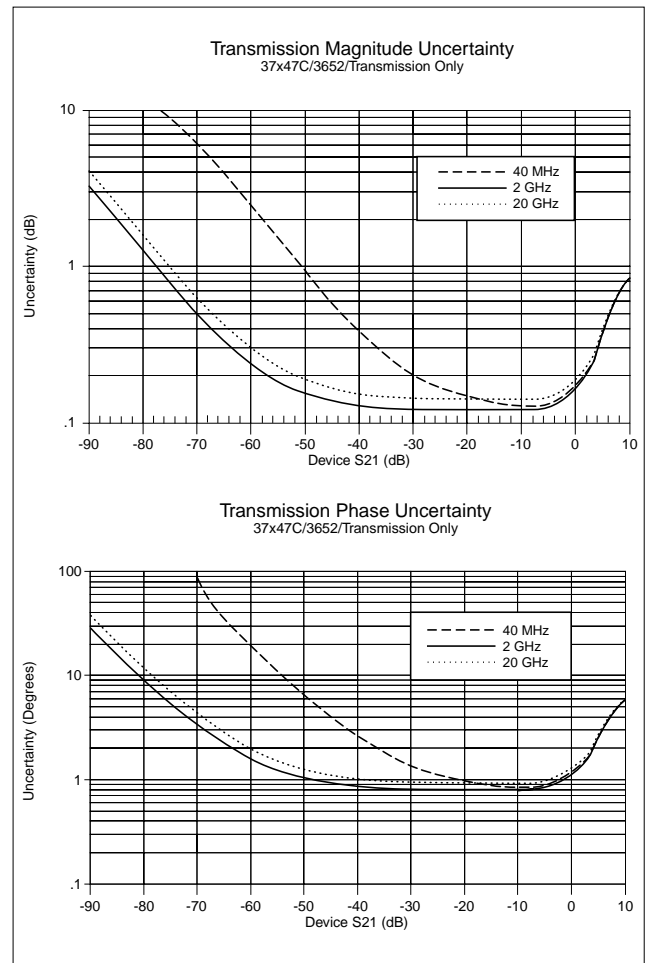

Models 37x69C Series (K-Connectors)

Reflection Measurements:

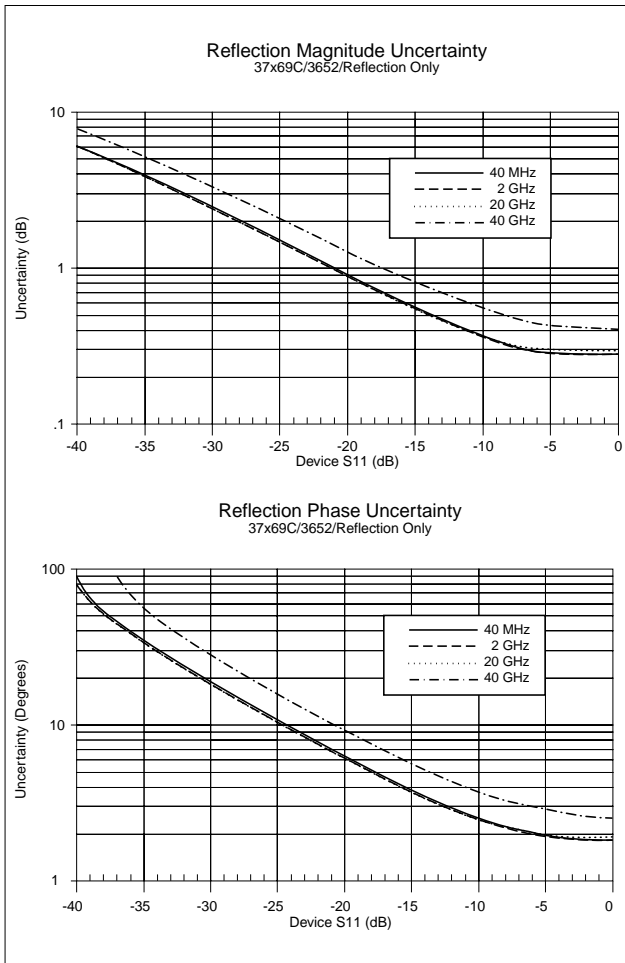

Models 37x69C Series (K-Connectors)

Transmission Measurements:

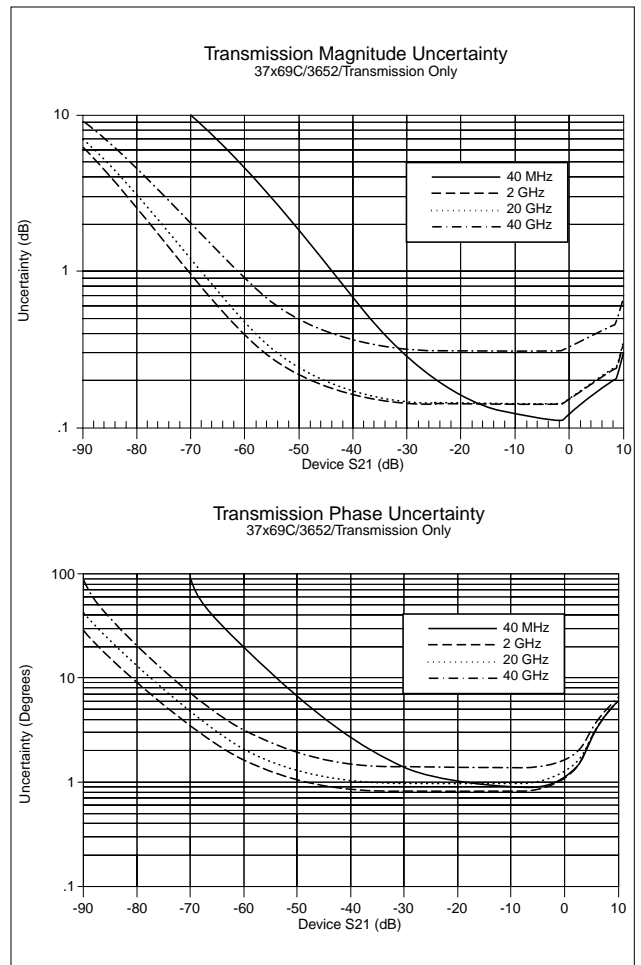

Model 37x77C and 37x97C (V-Connectors)

Reflection Measurements:

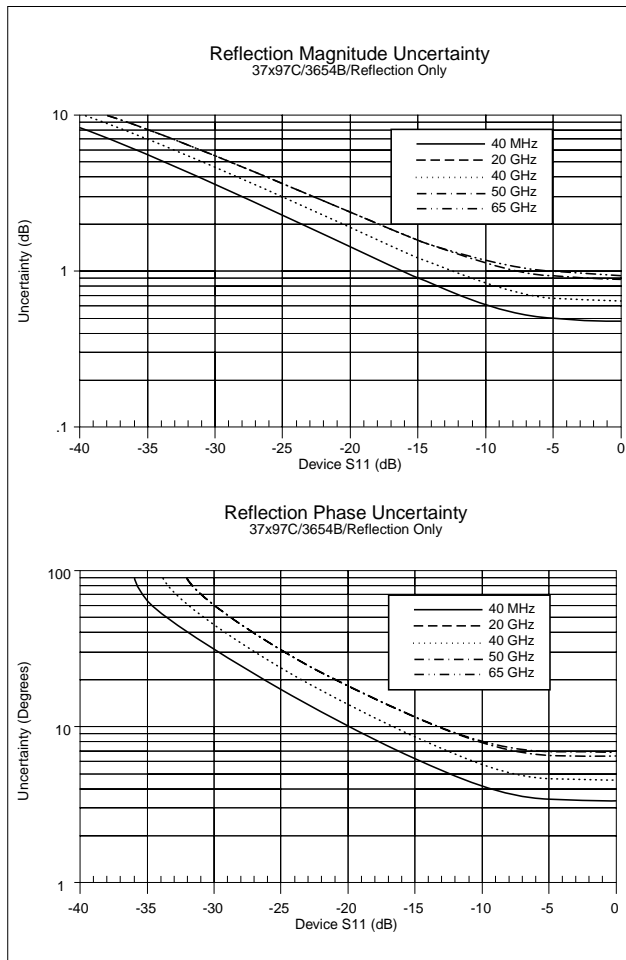

Model 37x77C and 37x97C (V-Connectors)

Transmission Measurements:

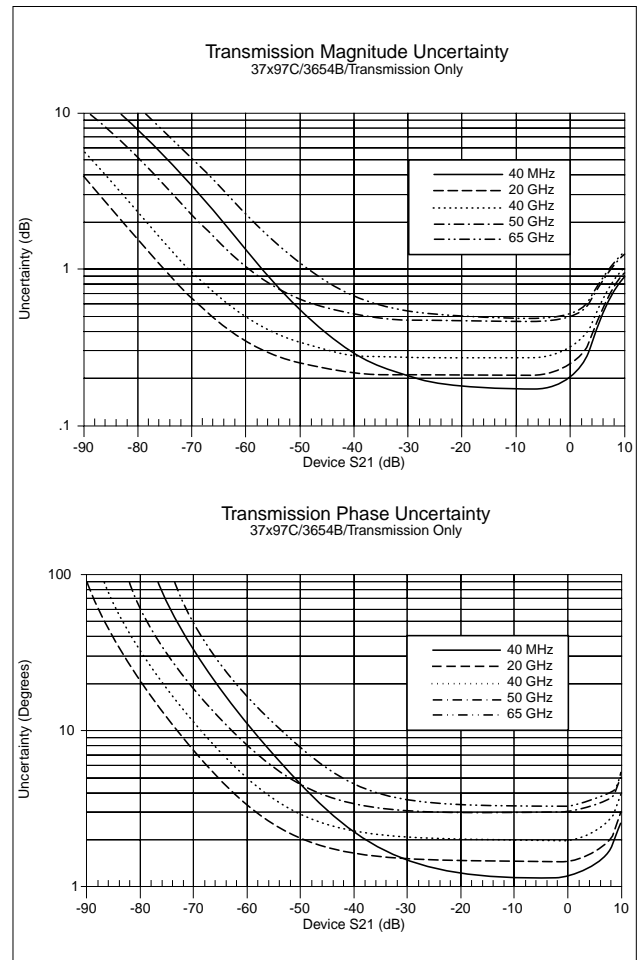

MEASUREMENT CAPABILITIES

Number of Channels: Four independent measurement channels.

Parameters: S11, S21, S22, S12, or user defined combinations of a1, a2, b1, and b2. All measurements are made without the need to manually reverse the test device. For the 37100C models, a reflectometer setup at the front end of the receiver is required for S-measurements. (See diagram on this page)

Measurement Frequency Range: Frequency range of measurement can be narrowed within the calibration range without recalibration. CW mode permits single frequency measurements, also without recalibration.

Domains: Frequency Domain, CW Draw, and optional High Speed Time (Distance) Domain.

Formats: Log Magnitude, Phase, Log Magnitude and Phase, Smith Chart (Impedance), Smith Chart (Admittance), Linear Polar, Log Polar, Group Delay, Linear Magnitude, Linear Magnitude and Phase, Real, Imaginary, Real and Imaginary, SWR and Power.

Data Points: 1601 maximum. Data points can be switched to a value of 801, 401, 201, 101 or 51 points without recalibration (if 1601 points were used in the calibration). In addition, the system accepts an arbitrary set of N discrete data points where $2 \leq N \leq 1601$. CW mode permits selection of a single data point without recalibration.

Reference Plane: Can be entered in time or in distance (when the dielectric constant is entered). Automatic reference plane feature adds the correct electrical length (delay) compensation at the push of a button. Software compensation for the electrical length difference between reference and test is always accurate and stable since measurement frequencies are always synthesized. In addition, the system compensates reference phase delay for dispersive transmission media, such as waveguide and microstrip.

Markers: Six independent markers can be used to read out measurement data. In delta-reference mode, any one marker can be selected as the reference for the other five. Markers can be directed automatically to the minimum or maximum of a data trace.

Enhanced Markers: Marker search for a level or bandwidth, displaying an active marker for each channel, and discrete or continuous (interpolated) markers.

Marker Sweep: Sweeps upward in frequency between any two markers. Recalibration is not required during the marker sweep.

Limit Lines: Either single or segmented limit lines can be displayed. Two limit lines are available for each trace.

Single Limit Readouts: Interpolation algorithm determines the exact intersection frequencies of test data and limit lines.

Segmented Limits: A total of 20 segments (10 upper and 10 lower) can be generated per data trace. Complete segmented traces can be offset in both frequency and amplitude.

Test Limits: Both single and segmented limits can be used for PASS/FAIL testing. The active channel's PASS or FAIL status is indicated on the display after each sweep. In addition, PASS/FAIL status is output through the rear panel I/O connector as selectable TTL levels (PASS=0V, FAIL=+5V or PASS=+5V, FAIL=0V).

Tune Mode: Tune Mode optimizes sweep speed in tuning applications by updating forward S-parameters more frequently than reverse ones. This mode allows the user to select the ratio of forward sweeps to reverse sweeps after a full 12-term calibration. The ratio of forward sweeps to reverse sweeps can be set anywhere between 1:1 to 10,000:1.

Data Averaging: 1 to 4096 averages can be selected. A front-panel button turns data averaging on/off, and an LED indicates when averaging is active.

Video IF Bandwidth: Front panel button selects four levels of video IF bandwidth: MAXIMUM (10 kHz), NORMAL (1 kHz), REDUCED (100 Hz) and MINIMUM (10 Hz).

Trace Smoothing: Functions similarly to Data Averaging but computes an average over a percentage range of the data trace. The percentage of trace to be smoothed can be selected from 0 to 20% of trace. Front-panel button turns smoothing on/off, and an LED indicates when smoothing is active.

Group Delay Aperture: Defined as the frequency span over which the phase change is computed at a given frequency point. The aperture can be changed without recalibration. The minimum aperture is the frequency range divided by the number of points in calibration and can be increased to 20% of the frequency range without recalibration. The frequency width of the aperture and the percent of the frequency range are displayed automatically.

Group Delay Range: The maximum delay range is limited to measuring no more than +180° of phase change within the aperture set by the number of frequency points. A frequency step size of 100 kHz corresponds to 10 ms.

DISPLAY CAPABILITIES

Measurement Channels: Four independent channels are available to display any S-parameter or user defined parameter, in any format, with up to two traces per channel for a maximum of eight traces simultaneously. A single channel, two channels (1 and 3, or 2 and 4), or all four channels can be displayed simultaneously. Channels 1 and 3, or channels 2 and 4 can be overlaid.

Display: Color LCD, 8.5" diagonal.

Display Colors: The color of data traces, memory, text, markers and limit lines are all user definable.

Trace Overlay: Displays two data traces on the active channel's graticule simultaneously.

Trace Memory: A separate memory for each channel can be used to store measurement data for later display or subtraction, addition, multiplication or division with current measurement data.

Scale Resolution (minimum per division):

Log Magnitude: 0.001 dB

Linear Magnitude: 1 pU

Phase: 0.01°

Group Delay: 0.001 ps

Time: 0.001 ms

Distance: 0.1 μm

SWR: 1 pU

Power: 0.01 dB

Autoscale: Automatically sets Resolution and Offset to fully display measurement data.

Reference Position: Can be set at any graticule line.

Annotation: Type of measurement, vertical and horizontal scale resolution, start/stop or center/span frequencies, and reference position.

Blank Frequency Information: Blanking function removes all references to frequencies on the display. Frequency references can only be restored through a system reset or GPIB command.

SIGNAL SOURCE CAPABILITIES

Frequency Resolution: 1 kHz (1 Hz standard on 37x17C and optional on Microwave units, Option 10A)

Source Power Level: The source power (dBm) may be set from the front panel menu or via GPIB. Check the graphs and tables on the following pages for the range.

In addition, on 37300C models, the port 1 power may be attenuated in 10 dB steps, using the internal 70 dB (60 dB for 37377C and 37397C) step attenuator. Similarly, high input signals into port 2, not exceeding 1 watt, can be attenuated up to 40 dB, using the internal port 2 step attenuator.

Power Accuracy: ±0.5 dB at 2 GHz at default power.

Power Meter Correction: The 37000C offers a user-selectable feature that corrects for test port power variations and slope (on Port 1) using an external power meter. Power meter correction is available at a user-selectable power level, if it is within the power adjustment range of the internal source. Once the test port power has been flattened, its level may be changed within the remaining power adjustment range of the signal source.

Set-On Receiver Mode: The 37300C can be configured to measure the relative harmonic level of test devices with Set-On Receiver Mode capability. The 37300C's unique phase locking scheme allows it to operate as a tuned receiver by locking all of its local oscillators to its internal crystal reference oscillator. Set-On Receiver Mode capability significantly increases the versatility of the 37300C VNA in applications that check for harmonics, intermodulation products, and signals of known frequency.

Multiple Source Control Capability: Multiple Source Control capability allows a user to independently control the frequencies of two sources and the receiver without the need for an external controller. The frequency ranges and output powers of the two sources may be specified. A frequency sweep may be comprised of up to five separate bands, each with independent source and receiver settings, for convenient testing of frequency translation devices such as mixers. Up to five sub-bands may be tested in one sweep. This feature enables users to easily test mixers, up/down converters, multipliers, and other frequency conversion devices.

Source #1: The 37000's internal source, or any of the 68XXXC, 69XXXB, 6700B or MG369XA synthesizers.

Source #2: Any of the 68XXXC, 69XXXB, 6700B or MG369XA synthesizers.

Sweep Type: Linear, CW, Marker, or N-Discrete point sweep.

Spurious Response (Harmonics):

15 dBc (37277C, 37297C, 37325C, 37347C, 37369C, 37377C, 37397C) at maximum rated power
35 dBc (all other models) at maximum rated power

Spurious Response (Nonharmonics):

35 dBc at maximum rated power

Phase Noise:

>60 dBc/Hz at 10 kHz offset and 20 GHz center frequency

Frequency Stability:

Standard Time Base:

Aging: <1 x 10⁻⁶/day

Stability: <1 x 10⁻⁶ over +15°C to +50°C range

High Stability Time Base (Option 10A):

Aging: <1 x 10⁻⁹/day

Stability: <5 x 10⁻⁹ over 0° to +55°C range

Power Range*

Model	Rated Power (dBm)	Minimum Power (dBm)	Resolution (dB)
37147C	+5	-15	0.05
37169C	-3	-23	0.05
37217C	0	-20	0.05
37225C	0	-20	0.05
37247C	0	-20	0.05
37269C	-15	-27	0.05
37277C	-7	-27	0.05
37297C	-7	-19	0.05
37317C	0	-95	0.05
37325C	+5	-90	0.05
37347C	+5	-90	0.05
37369C	-7	-97	0.05
37377C	-7	-87	0.05
37397C	-7	-79	0.05

Power Flatness

Frequency Range (GHz)	Flatness (dB)
0.0225 to 13.5	±1.5
13.5 to 20	±2.0
20 to 40	±3.0
40 to 65	±5.0

*Control Power for 37x17C, 37x25C, and 37x47C can be set to +10 dB but is not guaranteed. Similarly Control Power on the 37x69C, 37x77C, and 37x97C can be set to +20 dB but not guaranteed. Complete Control Power range also not guaranteed over temperature.

Available Source Power

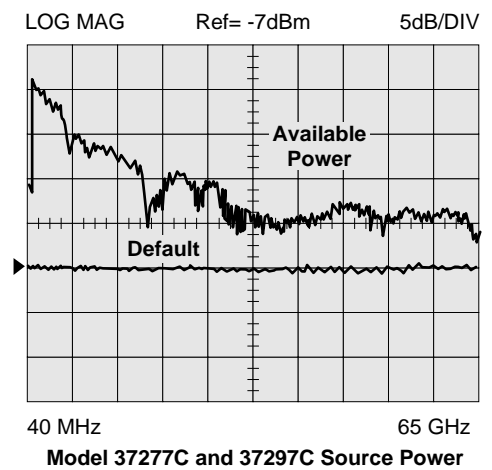
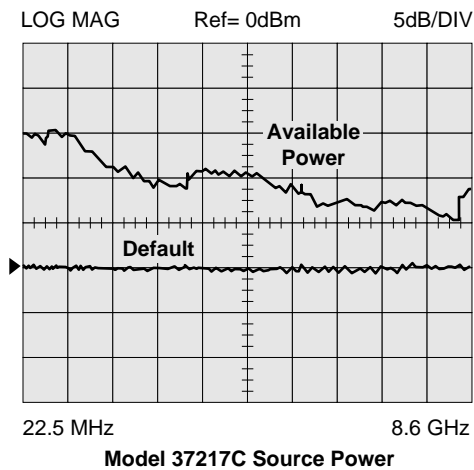
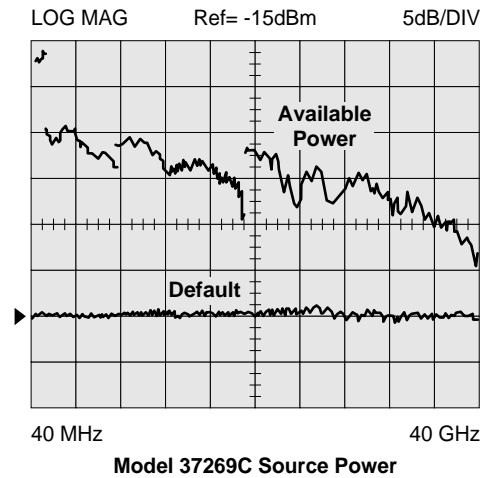
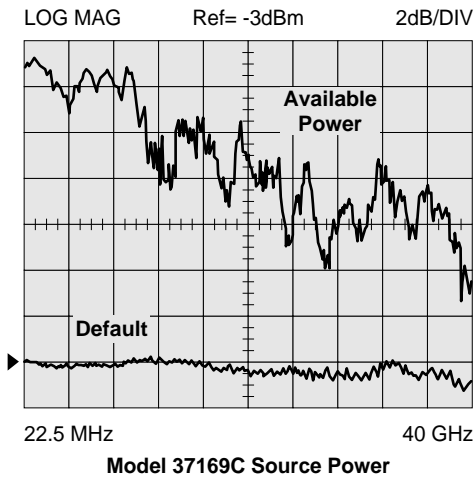
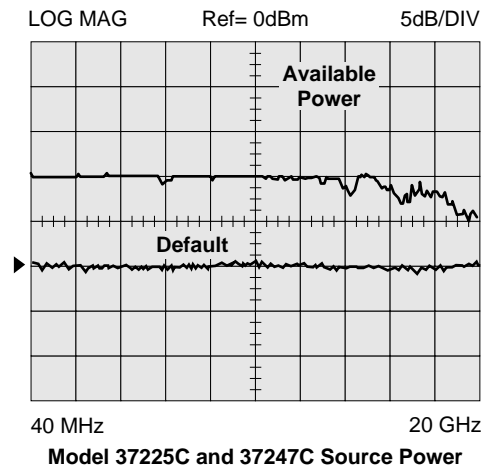
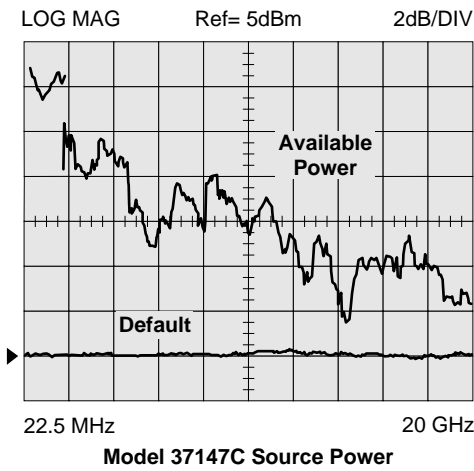

Available Source Power

LOG MAG Ref= 0dBm 5dB/DIV

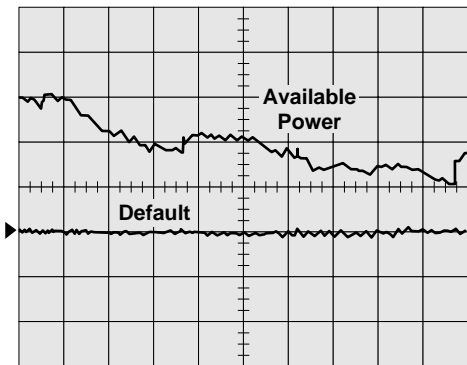

22.5 MHz 8.6 GHz
Model 37317C Source Power

LOG MAG Ref= -7dBm 5dB/DIV

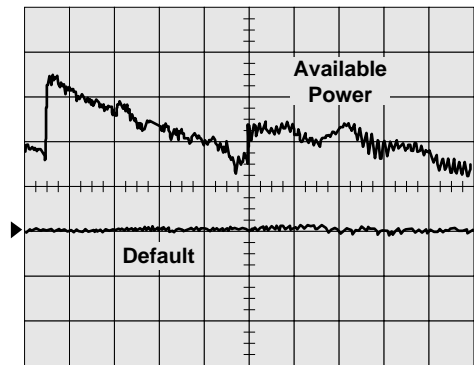

40 MHz 40 GHz
Model 37369C Source Power

LOG MAG Ref= 5dBm 5dB/DIV

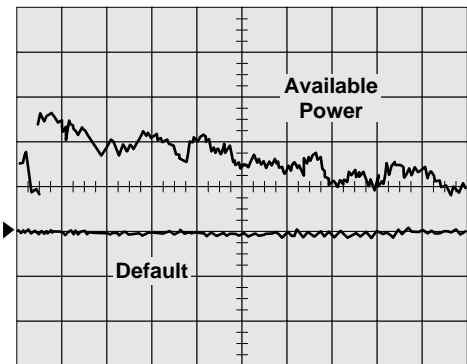

40 MHz 20 GHz
Model 37325C and 37347C Source Power

LOG MAG Ref= -7dBm 5dB/DIV

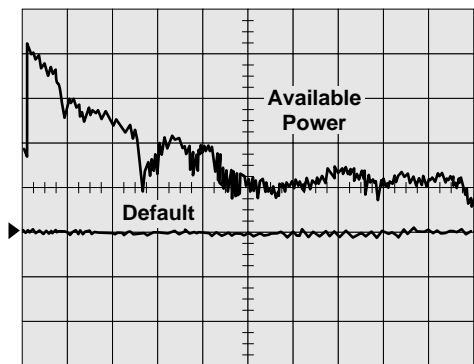

40 MHz 65 GHz
Model 37377C and 37397C Source Power

VECTOR ERROR CORRECTION

There are five built-in methods of calibration:

- 1) **Open-Short-Load-Thru (OSLT):** This calibration method uses short circuits, open circuits, and terminations (fixed or sliding)
- 2) **Offset-Short (waveguide):** This calibration method uses short circuits and terminations.
- 3) **LRL/LRM:** The Line-Reflect-Line (LRL) or Line-Reflect-Match (LRM) calibration uses transmission lines and a reflective device or termination (LRM).
- 4) **TRM:** The Thru-Reflect-Match calibration uses short circuits and fixed termination.
- 5) **AutoCal®:** This calibration method uses an automatic calibrator module.

There are four vector error correction models available for calibration:

- 1) **Full 12-Term**
- 2) **One Path/Two Port**
- 3) **Frequency Response**
- 4) **Reflection Only**

Full 12-Term can always be used, if desired, for all models that automatically reverse the test signal. Front-panel display indicates the type of calibration stored in memory. A front-panel button selects whether calibration is to be applied, and an LED lights when error correction data is being applied.

Calibration Sequence: Prompts the user to connect the appropriate calibration standard to Port 1 and/or Port 2. Calibration standards may be measured simultaneously or one at a time.

Calibration Standards: For coaxial calibrations the user selects SMA, 3.5 mm, GPC-7, Type N, 2.4 mm, TNC, K, V Connector or special type from the calibration menu. Use of fixed or sliding loads can be selected for each connector type. User defined calibration standards allow for entry of open capacitance, load and short inductances, load impedance, and reflection standard offset lengths.

Reference Impedance: It is possible to modify the reference impedance of the measurement to other than 50Ω (but not 0).

AutoCal®: The VNA can internally control an external AutoCal module to perform a 2-port OSLT calibration. AutoCal is a single two port calibration module with built-in, switched, and characterized OSLT standards. AutoCal provides quick, reliable, and accurate calibrations that exceed the performance of a standard broadband load OSLT calibration.

LRL/LRM Calibration: The LRL calibration technique uses the characteristic impedance of a length of transmission line as the calibration standard. A full LRL calibration consists merely of two transmission line measurements, a high reflection measurement, and an isolation measurement. The LRM calibration technique is a variation of the LRL technique that utilizes a precision termination rather than a second length of transmission line. A third optional standard, either Line or Match, may be measured in order to extend the frequency range of the calibration. This extended calibration range is achieved by mathematically concatenating either two LRL, two LRM, or one LRL and one LRM calibration(s). Using these techniques, full 12-Term error correction can be performed on the 37000C models.

Adapter Removal Calibration: Built-in Adapter Removal application software accurately characterizes and "removes" any adapter used during calibration that will not be used for subsequent device measurements. This technique allows for accurate measurement of non-insertable devices.

Dispersion Compensation: Selectable as Coaxial (non-dispersive), Waveguide, or Microstrip (dispersive).

GAIN COMPRESSION MEASUREMENT CAPABILITY (37300C models only)

The 37300C simplifies amplifier Gain Compression and AM/PM measurements. Once an appropriate power and frequency schedule is selected, a power meter calibration, at a set level, will calibrate the linear VNA receiver channels, to accurately measure power in dBm. The 37300C supports the Anritsu, Giga-tronics, and Agilent power meters. To measure power, $b_2/1$, a user defined parameter, is automatically selected.

Swept Power Gain Compression: The 37300C will display traditional Power out vs. Power in or Phase vs. Power in, at one of up to 10 selectable frequencies. A separate screen will easily show Power out and Power in at 1 dB, or selected level Gain Compression, for all entered frequencies. (Check figure below)

Swept Frequency Gain Compression: Once Gain is measured at the starting power, the user increments Power in, observing Normalized Gain vs. Frequency. This aids in analyzing the most critical compression frequencies of a broadband amplifier.

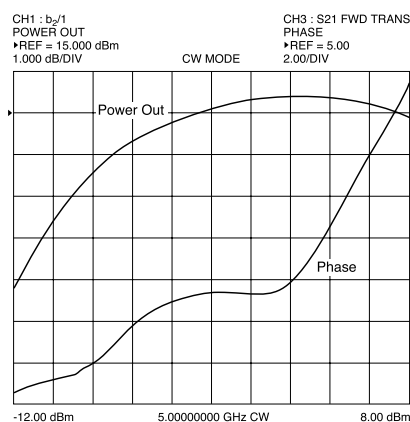

Shows Power Out and Phase performance as a function of Input Power at a CW frequency.

HIGH SPEED TIME (DISTANCE) DOMAIN MEASUREMENT CAPABILITY (OPTION 2)

Option 2, High Speed Time (Distance) Domain software allows the conversion of reflection or transmission measurements from the frequency domain to the time domain. Measured S-parameter data is converted to the time domain by application of a Fast Fourier Transform (FFT) using the Chirp Z-Transform technique. Prior to conversion any one of several selectable windowing functions may be applied. Once the data is converted to the time domain, a gating function may be applied to select the data of interest. The processed data may then be displayed in the time domain with display start and stop times selected by the user or in the distance domain with display start and stop distance selected by the user. The data may also be converted back to the frequency domain with a time gate to view the frequency response of the gated data.

Lowpass Mode: This mode displays a response equivalent to the classic "TDR" (Time Domain Reflectometer) response of the device under test. Lowpass response may be displayed in either the impulse or step mode. This type of processing requires a sweep over a harmonic series of frequencies and an extrapolated or user-entered DC value.

Bandpass Mode: This mode displays a response equivalent to the time response of the device under test to a band limited impulse. This type of processing may be used with any arbitrary frequency sweep range, limited only by the test set range or device under test response.

Phasor Impulse Mode: This mode displays a response similar to the Lowpass impulse response, using data taken over an arbitrary (band limited) sweep range. Detailed information, similar to that contained in the lowpass impulse response may be used to identify the nature of impedance discontinuities in the device under test. Now, with Phasor Impulse, it is possible to characterize complex impedances on band-limited devices.

Windowing: Any one of four window functions may be applied to the initial frequency data, to counteract the effects of processing data with a finite bandwidth. These windows provide a range of trade offs of main lobe width versus sidelobe level (ringing). The general type of function used is the Blackman-Harris window with the number of terms being varied from one to four. Typical performance follows:

Type of Window (Number of Terms)	First Side Lobe Relative to Peak	Impulse Width ¹
Rectangle (1)	-13 dB	1.2W
Nominal-Hamming (2)	-43 dB	1.8W
Low Side Lobe, Blackman-Harris (3)	-67 dB	2.1W
Minimum Side Lobe, Blackman-Harris (4)	-92 dB	2.7W

¹W(Bin Width) = 1/2Δf sweep width.

Example. When Δf = 40 MHz to 40 GHz, W = 12.5 ps
When Δf = 40 MHz to 65 GHz, W = 7.7 ps

Gating: A selective gating function may be applied to the time domain data to remove unwanted responses, either in a pass-band or reject-band (mask). This gating function may be chosen as the convolution of any of the above window types with a rectangular gate of user defined position and width. The gate may be specified by entering start and stop times or center and span. The gated data may be displayed in the time domain, or converted back to the frequency domain.

Time Domain Display: Data processed to time domain may be displayed as a function of time or as a function of distance, provided the dielectric constant of the transmission media is entered correctly. In the case of dispersive media such as waveguide or microstrip, the true distance to a discontinuity is displayed in the distance mode. The time display may be set to any arbitrary range by specifying either the start and stop times or the center time and span. The unaliased (non-repeating) time range is given by the formula:

$$\text{Unaliased Range (ns)} = \frac{\text{Number of Frequency Data Points}}{\text{Frequency Sweep Range (GHz)}}$$

The resolution is given by the formula:

$$\text{Main Lobe Width (null-null) in ns} = \frac{kW}{\text{Freq. Sweep Range (GHz)}}$$

where kW is two times the number of window terms (for example, four for a two-term window)

For a 40 GHz sweep range with 1601 data points, the unaliased range is 40.025 nanoseconds. For a 65 GHz sweep with 1601 data points, the unaliased range is 24.646 nanoseconds.

Frequency with Time Gate: Data that has been converted to time domain and selected by the application of gating function may be converted back to the frequency domain. This allows the display of the frequency response of a single element contained in the device under test. Frequency response accuracy is a function of window and gate type, and gate width. For a full reflection, minimum gate and window accuracy is within 0.2 dB of the ungated response over a 40 GHz range.

GPIB

GPIB INTERFACES: 2 Ports, system GPIB and dedicated GPIB

System GPIB (IEEE-488.2): Connects to an external controller for use in remote programming of the network analyzer. Address can be set from the front panel and can range from 1 to 30.

Dedicated GPIB: Connects to external peripherals for network analyzer controlled operations (e.g. GPIB plotters, frequency counters, frequency synthesizers and power meters).

Interface Function Codes: SH1, AH1, T6, TE0, L4, LE0, SR1, RL1, PP1, DT1, DC0, C0.

GPIB Data Transfer Formats: ASCII, 32-bit floating point, or 64-bit floating point. 32-bit and 64-bit floating point data can be transferred with LSB or MSB first.

GPIB Data Transfer Speed (with or without cal):
150 kbyte/sec

GPIB Data Throughput Time: Throughput measurements for both tables were made as follows: start the timer, trigger a sweep, wait for a full sweep, transfer data across the GPIB and stop the timer. Data throughput times are shown separately for measurements made without calibration and with full two-port, 12-Term calibration. Measurement conditions: 40 MHz to 20 GHz sweep, single channel, log magnitude display, 10 kHz IF bandwidth, and output final data.

Throughput Times (ms) without Correction (typical)

Data Format	3 Points*	101 Points	401 Points	1601 Points
32 Bit	150	500	1200	3600
64 Bit	150	500	1200	3600
ASCII	150	600	1500	4400

*3 data point sweeps taken at 2, 4, and 6 GHz

Throughput Times (ms) with 12-Term Correction (typical)

Data Format	3 Points*	101 Points	401 Points	1601 Points
32 Bit	190	950	2300	6900
64 Bit	190	950	2300	6900
ASCII	190	1000	2500	7400

*3 data point sweeps taken at 2, 4, and 6 GHz

Fast CW Operation: Fast CW is an ideal mode of operation for rapid data taking over GPIB. To achieve a fast measurement rate the display is not updated and only the raw S-parameter or user-defined parameter of the active channel is measured.

Fast CW Typical Performance

Trigger Mode	Measurement Speed (ms/point)
GPIB	1.5
External TTL	1.2
Internal	0.8

Internal Buffer Data Collection: Internal Buffer Data Collection is provided to allow saving active channel measurement data from multiple sweeps without having to synchronize and collect data at the end of each sweep. The 37000C can store up to 50,000 data point measurements, each consisting of two (real and imaginary) IEEE 754 4-byte floating point numbers. GPIB transfer speed for the 50,000 data points is typically 2.2 seconds.

STORAGE

Internal Memory: Ten front panel states (no calibration) can be stored and recalled from non-volatile memory locations. The current front panel setup is automatically stored in non-volatile memory at instrument power-down. When power is applied, the instrument returns to its last front panel setup.

Internal Hard Disk Drive: 340 MB min., used to store and recall measurement and calibration data and front-panel setups. All files are MS-DOS® compatible. File names can be 1 to 8 characters long, and must begin with a character, not a number. Extensions are automatically assigned.

External SCSI Interface: Option 4 deletes the internal hard disk drive, and adds a SCSI Interface connector to the rear panel for connecting a SCSI-2 formatted hard disk drive.

Internal Floppy Disk Drive: A 3.5-inch diskette drive with 1.44 Mbytes formatted capacity is used to load measurement programs and to store and recall measurement and calibration data and front-panel setups. Measurement data can be stored in text, S2P or Bitmap format. All files are MS-DOS compatible. File names can be 1 to 8 characters long, must begin with a character, not a number. Extensions are automatically assigned.

Measurement Data: 102.8 kbytes per 1601 point S-parameter data file.

Calibration Data: 187.3 kbytes per 1601 point S-parameter data file (12-Term cal plus setup).

Trace Memory File: 12.8 kbytes per 1601 point channel.

HARD COPY

Printer: Menu selects full screen, graphical, tabular data, and printer type. The number of data points of tabular data can be selected as well as data at markers only. Compatible with most HP and Epson printers with Parallel (Centronics) interfaces.

GPIB Plotter: The 37000 is compatible with most HP and Tektronix plotters. Menu selects plotting of full or user-selected portions of graphical data. Plotter is connected to the dedicated GPIB bus.

Performance: After selecting the Start Print button, front panel operation and measurement capability is restored to the user within 2 seconds.

INTERFACES

37000C Front Panel Connectors and Controls:

Keyboard Input: An IBM-AT compatible keyboard can be connected to the front panel for navigating through front panel menus, annotation of data files and display labels, printing displays and pausing instrument sweeps.

Test Ports (37200C and 37300C): Universal/K, male, connectors are standard on all models except for the >40 GHz models which have Universal V male test ports as standard. For additional configurations check Test Port Converters (Option 7).

Bias Inputs, Port 1 and 2 (37300C): 0.5 amps maximum through BNC connectors.

Source Input Loop (37100C): Provides external source input capability, replacing the internal source.

RF Output (37100C): K, female, provides source RF output.

a₁, a₂, b₁, b₂ Inputs (37100C): K, female, provide inputs to the samplers.

Source Lock Output (37100C): Provides a sample of the internal source, at -9 dB (typical) relative to the internal source power.

Port 1 Amplifier Loop (37300C): Provides access to insert an external amplifier, ahead of the port 1 coupler or bridge, to increase port 1 power output, up to +30 dBm (1 watt) maximum.

37000C Rear Panel Connectors and Controls:

PRINTER OUT: Centronics interface for an external printer.

VGA OUT: Provides VGA output of 37000C video display.

SERIAL: 9-Pin male DSUB connector. Provides RS-232 serial port control for an AutoCal[®] module (3658 series).

10 MHz REF IN: Connects to external reference frequency standard, 10 MHz, +5 to -5 dBm, 50 Ω, BNC female.

10 MHz REF OUT: Connects to internal reference frequency standard, 10 MHz, 0 dBm, 50 Ω, BNC female.

EXT ANALOG OUT: -10V to +10V with 5 mV resolution, varying in proportion to user-selected data (e.g., frequency, amplitude). BNC female.

EXT ANALOG IN: ±50 volt input for displaying external signals on the LCD. BNC female.

LINE SELECTION: Power supply automatically senses 100V, 120V, 220V or 240V lines.

EXTERNAL TRIGGER: External TTL triggering for 37000C measurement. 10 kΩ input impedance, BNC female.

REFERENCE EXTENSION: The 37300C provides access to the a₁ and b₁ samplers as standard. The 37200C provides access to a₁ as an option. K female connectors are used, except for >40 GHz models where V female connectors are used.

EXTERNAL SCSI: Provides SCSI-2 connector for connection of an external SCSI hard disk drive (Option 4).

EXTERNAL I/O: 25-pin DSUB connector.

LIMITS PASS/FAIL: Selectable TTL levels (Pass=0V, Fail=+5V or Pass=+5V, Fail=0V. Additionally, 0 volts (all displayed channels pass) or +5V (any one of 4 displayed channels fail) output pass/fail status (1 line).

PORT 1 SOURCE ATTENUATOR (37100C): Drive signal for a source external programmable step attenuator.

PORT 2 TEST ATTENUATOR (37100C): Drive signal for a test external programmable step attenuator.

TRANSFER SWITCH (37100C): Drive signal for an external transfer switch.

GENERAL

Power Requirements: 85-240 volts, 48-63 Hz, 540 VA maximum

Dimensions: 267 H x 432 W x 585 D mm
(10.5 H x 17 W x 23 D in.)

Weight: 27 kg (60 lb)-(2-man lift required).

Storage Temperature Range: -40°C to +75°C

Operating Temperature Range: 0°C to +50°C

Relative Humidity: 5% to 95% at +40°C

EMI: Meets the emissions and immunity requirements of EN55011/1991 Class A/CISPR-11 Class A

EN50082-1/1993

IEC 801-2/1984 (4 kV CD, 8 kV AD)

IEC 1000-4-3/1995 (3 V/m, 80-1000 MHz)

IEC 801-4/1988 (500V SL, 1000V PL)

IEC 1000-4-5/1995 (2 kV L-E, 1 kV L-L)



*LRL/LRM—Calibration method of Rohde & Schwarz, Germany.
GPC-7 is a registered trademark of Amphenol Corporation.
K Connector and V Connector are registered trademarks of Anritsu Company.
MS-DOS is a registered trademark of Microsoft Corporation.*



CE



Sales Centers:

United States (800) ANRITSU
Canada (800) ANRITSU
South America 55 (21) 286-9141

Anritsu

Discover What's Possible™

Microwave Measurements Division • 490 Jarvis Drive • Morgan Hill, CA 95037-2809
<http://www.us.anritsu.com> • FAX (408) 778-0239

Sales Centers:

Europe 44 (0) 1582 433433
Japan 81 (03) 3446-1111
Asia-Pacific 65-2822400